

High-Intensity Green LED in Plastic T-1³/₄ Package

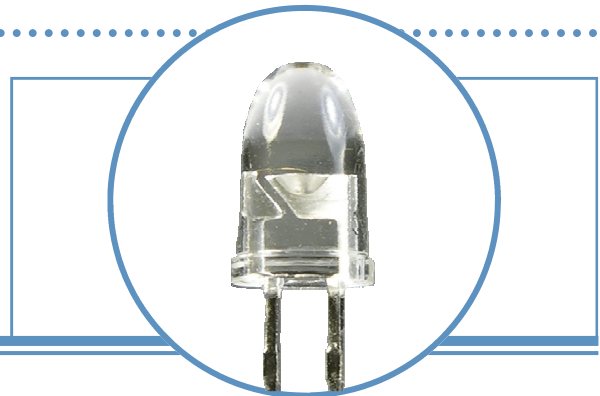

OVLGG0Cx9

- Narrow Beam Angle
- High Luminous Intensity
- Water Clear Plastic Package
- Green (525nm)



The OVLGG0Cx9 is a high intensity InGaN LED mounted in a clear plastic T-1³/₄ package. The device incorporates an integral molded lens that enables a narrow beam angle and provides an even emission pattern. Designed to produce light over a wide range of drive currents, this LED is useful in applications requiring higher on-axis brightness than that achievable with standard lamps.

Applications

- Indoor/Outdoor Applications
- Message Boards
- Store Front Signage
- Indicators

| Part Number | Material | Emitted Color | Intensity Typ. mcd | Lens Color |
|-------------|----------|---------------|--------------------|-------------|
| OVLGG0C4B9 | InGaN | Green | 4000 | Water Clear |
| OVLGG0C5B9 | | | 5000 | |
| OVLGG0C6B9 | | | 6300 | |

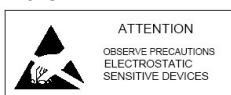
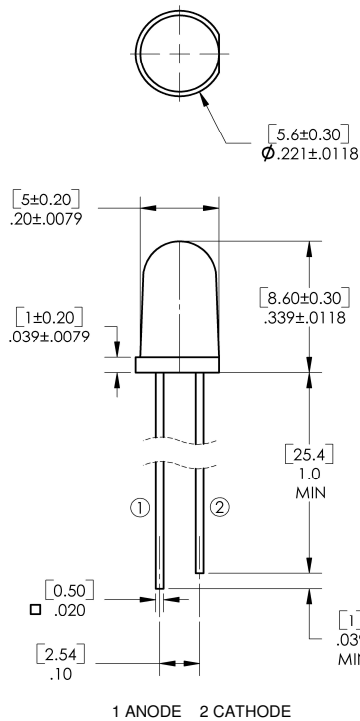

OPTEK reserves the right to make changes at any time in order to improve design and to supply the best product possible.

T-1 $\frac{3}{4}$ High-Intensity Green LED

OVLGG0CxB9



Absolute Maximum Ratings

T_A = 25°C unless otherwise noted

| | |
|---|---------------|
| Storage Temperature Range | -40 ~ +100 °C |
| Operating Temperature Range | -40 ~ +85 °C |
| Reverse Voltage | 5 V |
| Continuous Forward Current ² | 25 mA |
| Peak Forward Current (10% Duty Cycle, 1KHz) | 100 mA |
| Power Dissipation | 100 mW |
| Lead Soldering Temperature (3mm from the base of the epoxy bulb) ¹ | 260 °C |
| Electrostatic Discharge | 150 V |

Note:

1. Solder time less than 5 seconds at temperature extreme.

Electrical Characteristics

T_A = 25°C unless otherwise noted

| SYMBOL | PARAMETER | MIN | TYP | MAX | UNITS | CONDITIONS | |
|----------------------|---------------------|-------|------|------|-------|-----------------------|-----------------------|
| I _v | Luminous Intensity | x = 4 | 2500 | 4000 | ---- | mcd | I _F = 20mA |
| | | 5 | 3200 | 5000 | ---- | | |
| | | 6 | 4000 | 6300 | ---- | | |
| V _F | Forward Voltage | ---- | 3.5 | 4.0 | V | I _F = 20mA | |
| I _R | Reverse Current | ---- | ---- | 50 | μA | V _R = 5V | |
| λ _P | Peak Wavelength | ---- | 518 | ---- | nm | I _F = 20mA | |
| λ _D | Dominant Wavelength | ---- | 525 | ---- | nm | I _F = 20mA | |
| 2Θ $\frac{1}{2}$ H-H | 50% Power Angle | ---- | 6 | ---- | deg | I _F = 20mA | |

Typical Electro-Optical Characteristics Curves

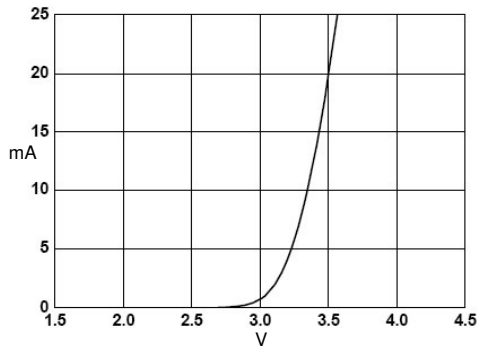

Forward Current vs. Forward Voltage

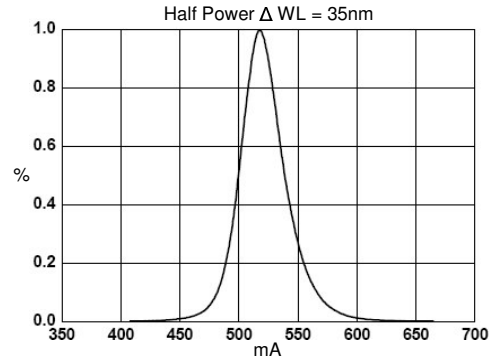

Relative Luminous Intensity vs. Wavelength

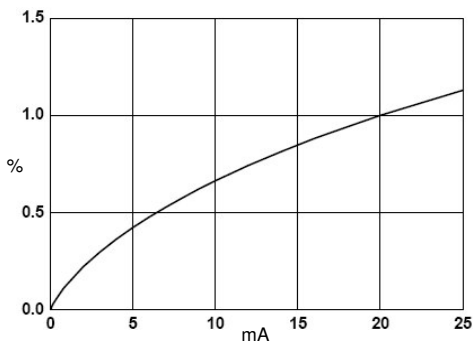

Relative Luminous Intensity vs. Forward Current

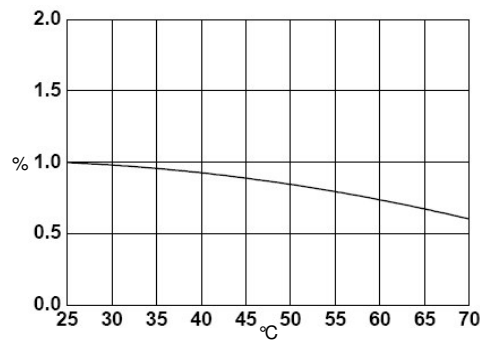

Relative Luminous Intensity vs. Ambient Temperature

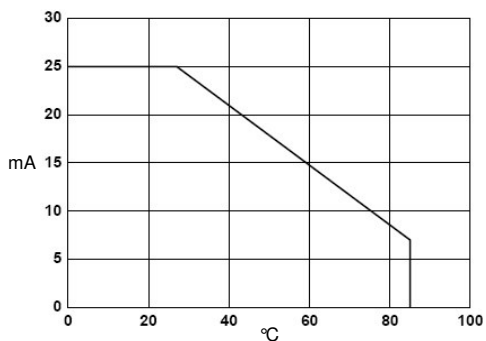

Forward Current vs. Ambient Temperature

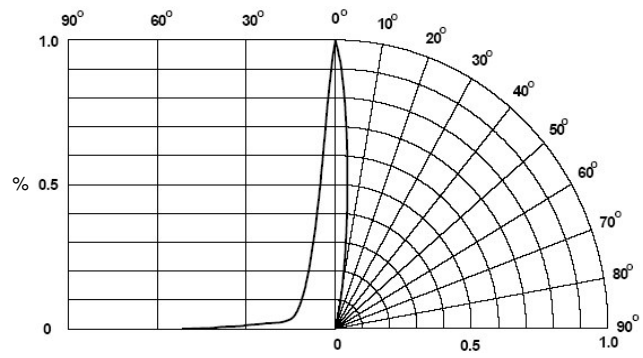

Relative Intensity vs. Radiation Angle

T-1 $\frac{3}{4}$ High-Intensity Green LED

OVLGG0Cx B9

| Issue | Change Description | Approval | Date |
|-------|--------------------|-----------|--------|
| 1.0 | Initial Release | J. Haynie | 6/7/05 |
| | | | |
| | | | |
| | | | |
| | | | |
| | | | |
| | | | |
| | | | |
| | | | |
| | | | |
| | | | |
| | | | |
| | | | |
| | | | |
| | | | |
| | | | |
| | | | |
| | | | |
| | | | |
| | | | |
| | | | |
| | | | |
| | | | |
| | | | |
| | | | |
| | | | |
| | | | |
| | | | |
| | | | |
| | | | |
| | | | |
| | | | |
| | | | |
| | | | |
| | | | |
| | | | |
| | | | |